

KASPIAN

S128-REG2W2S

A	B	C	D
1	S508-0020	1468	408
2	S508-0021	1468	408
3	S508-0022	822	176
4	S508-1001	1964	396
5	S508-1002	1964	396
6	S508-2009	900	399,
7	S508-3012	863	370
8	S508-3013	862	368
9	S508-4017	863	82
10	S508-4018	863	60
11	S508-9308	1511,	893
12	WSP-9293	798,	355
13	ZS7-5038	778	110
14	ZS7-521	350	110
15	ZS7-522	350	110

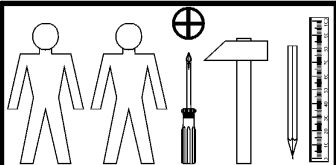
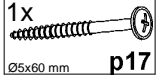
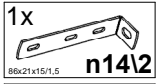
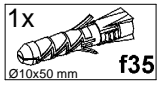
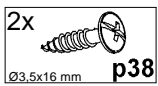
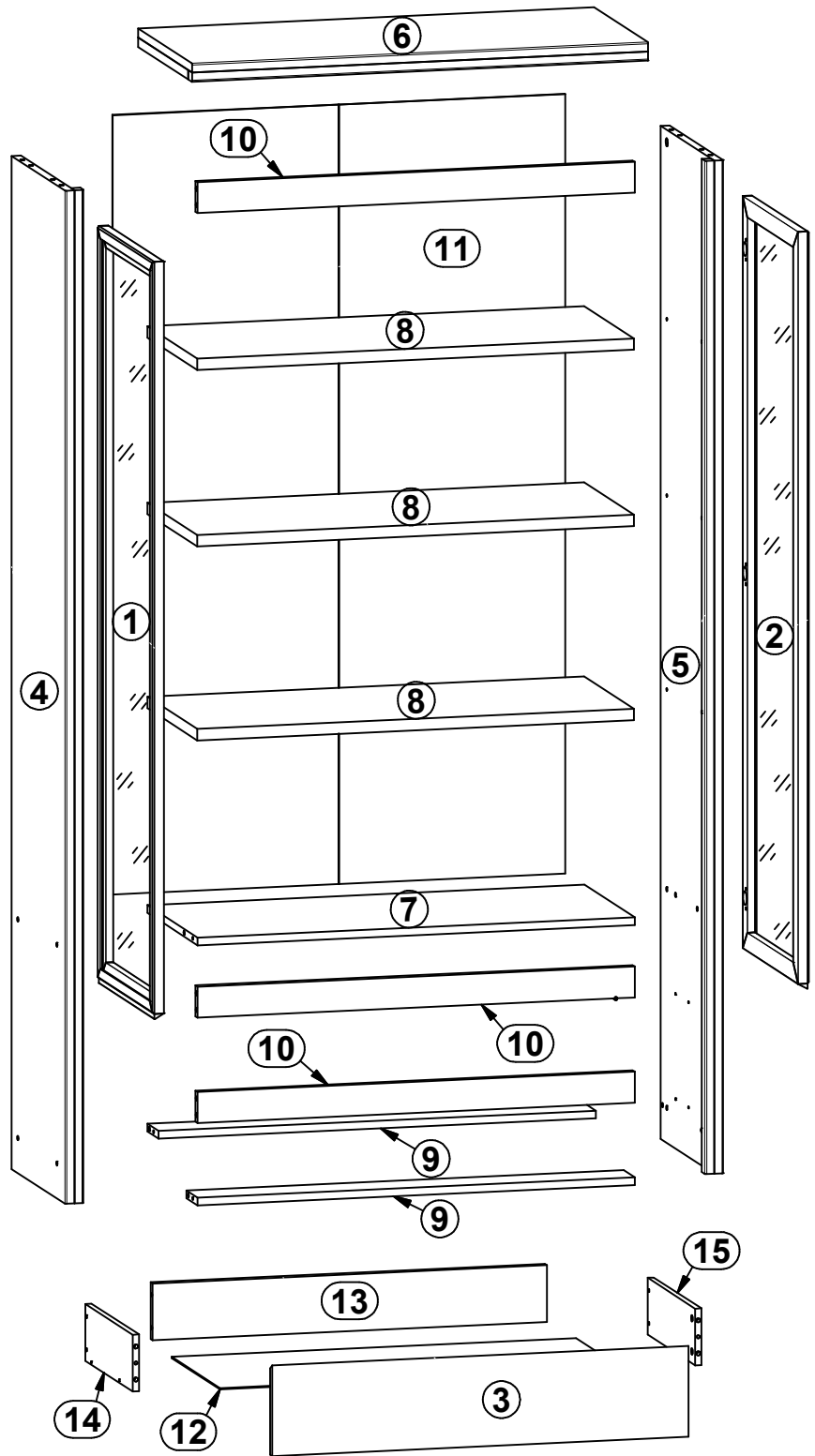
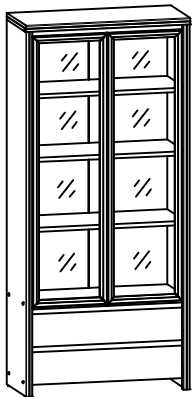

6x a1	6x b12	6x b44	12x φ5x17 mm d1	8x φ7x50 mm e1	12x φ6x30 mm e16	8x φ5x9 mm e19	12x φ6.3x30 mm e23	24x φ8x30 mm f1
8x φ6.5x40 mm f25	4x k1	65x l1	2x φ3.5x16 mm p25	4x φ1.5x12mm #16 r1	8x φ12x10.5mm #12 r15	12x r42	8x s1	2x φ16 s2
2x 350 mm t35	12x h=18 mm w36	2x 350 mm w45\CL	2x 350 mm w45\CR	2x 350 mm w45\DL	2x 350 mm w45\DR	1x z1	2x Ø3.5x10 mm p35	4x Ø6x30 mm f9

1

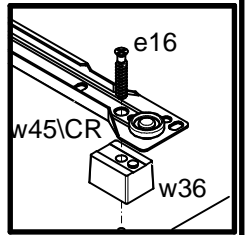
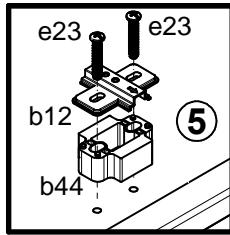
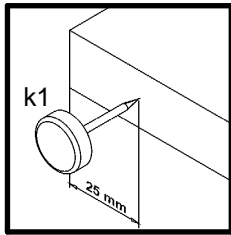
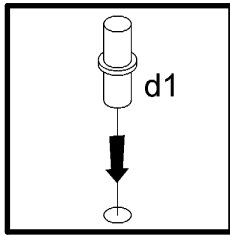
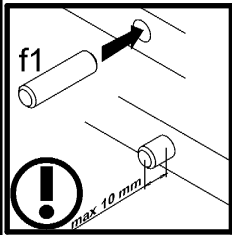
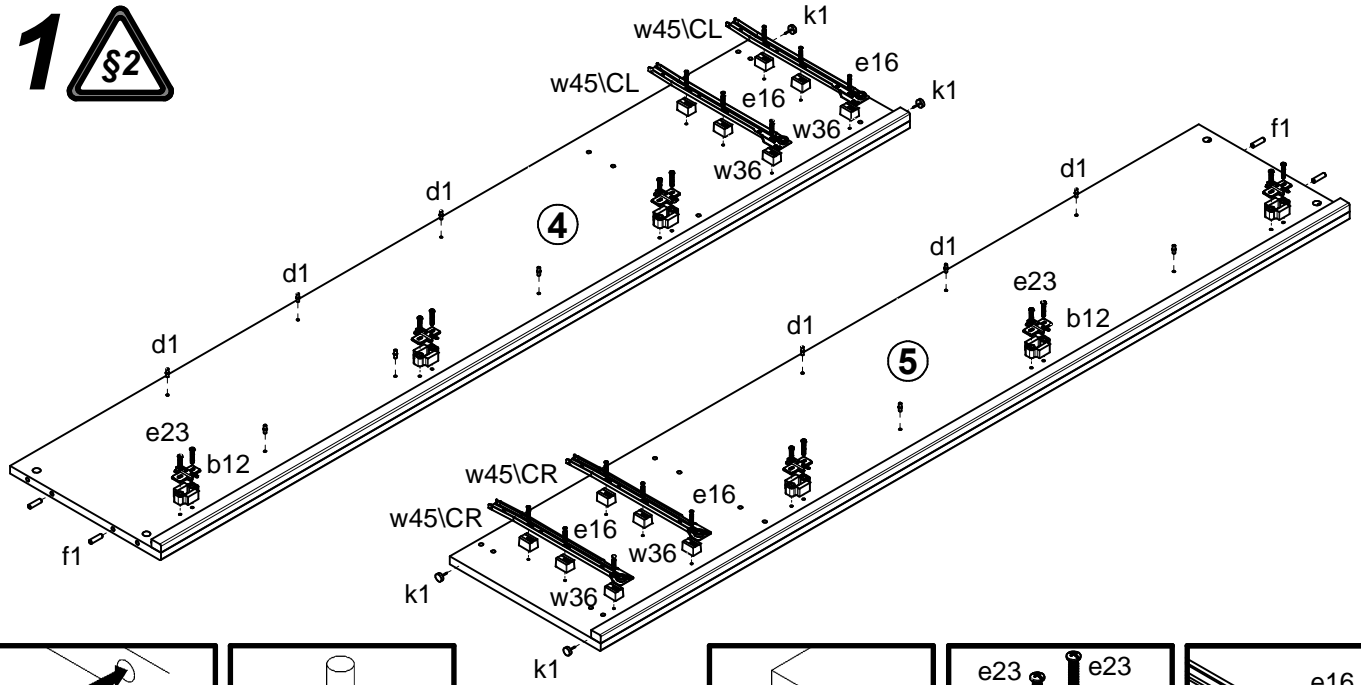

2

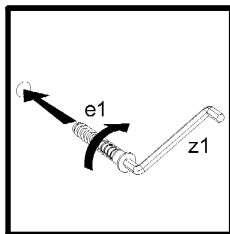
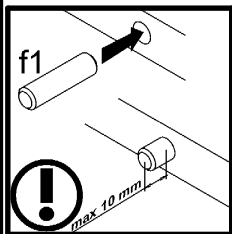
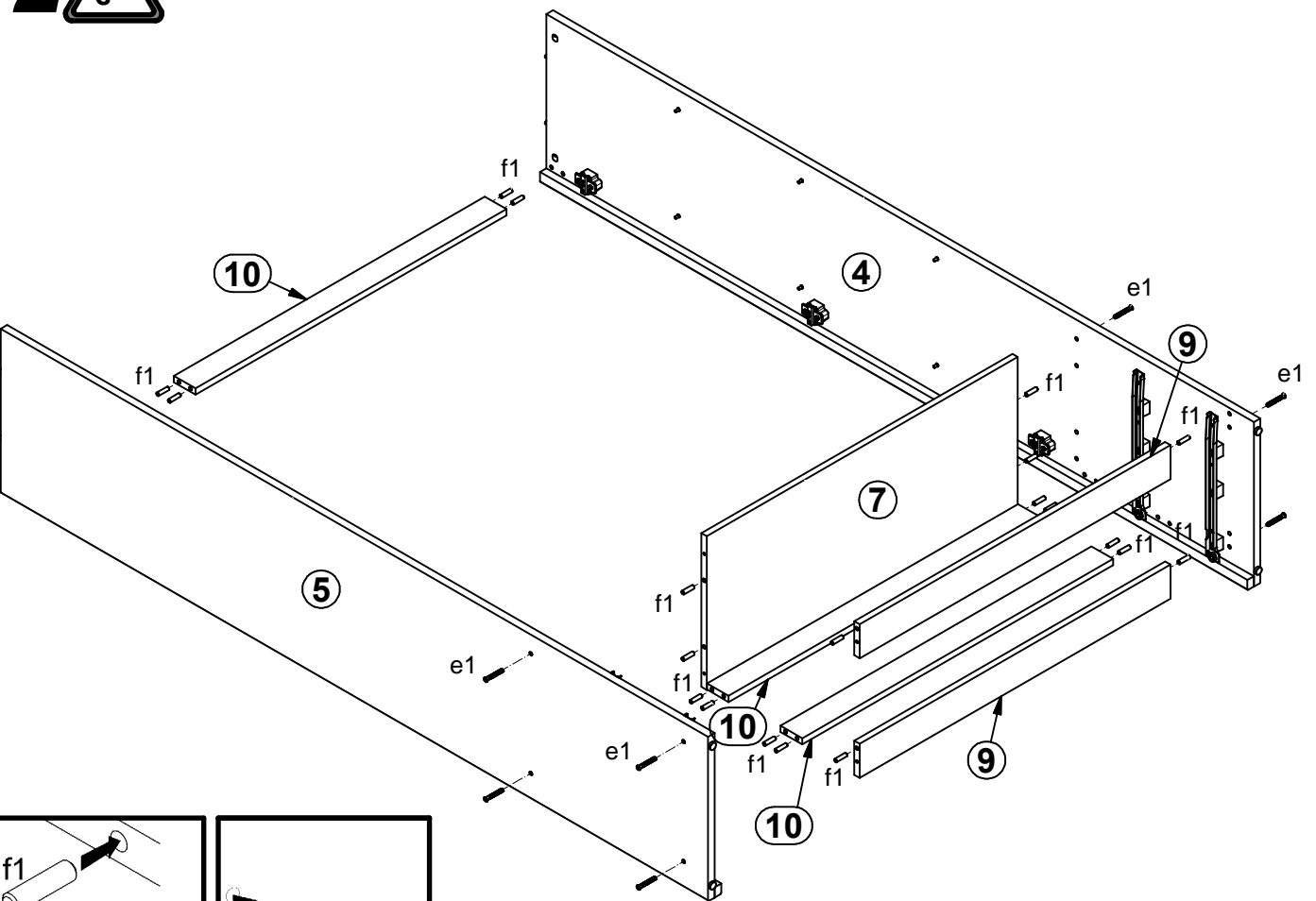

3

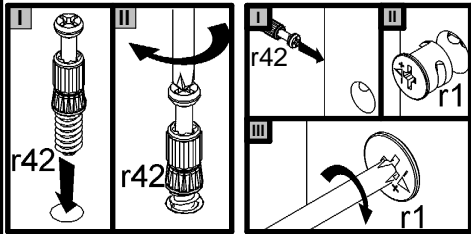
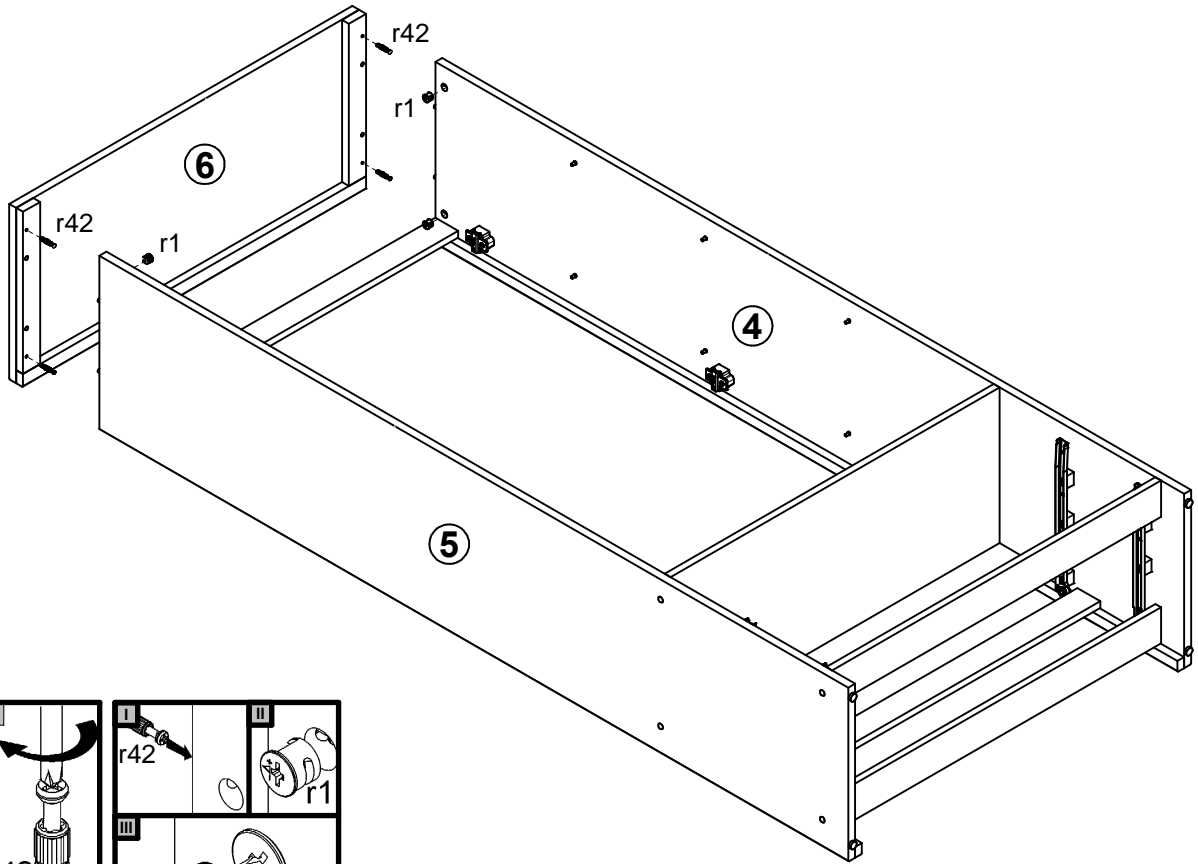

4

