

A	B	C	D
1	S171-105	1075x346	1/2
2	S171-106	1075x346	1/2
3	S171-302A	757x309	1/2
4	S363-003	1069x376	2/2
5	S363-005	1069x376	2/2
6	S363-214	791x350	1/2
7	S363-204	791x350	1/2
8	S363-903	1089x771	2/2

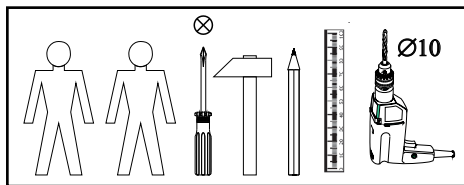

4x K16 a43	4x D5 b19	2x L=200/128 mm c450 ¹	8x φ5 d1	4x φ7x50 mm e1	8x φ8x30 mm f1	1x φ10x50 mm f35	4x 56x56/20 mm k52	4x ø16 s2
6x I2	1x 40x12x3.5 mm I68	4x φ4.5/φ6.5x5 mm o29	4x φ4x30 mm p9	1x φ5x60 mm p17	8x φ4x30 mm p21	2x φ3,5x16 mm p38	4x φ2,9x16 mm p55	1x z33
8x φ3,5x15 mm p51	8x φ3,5x16 mm p61	2x n8/3	2x n8/4	1x 81x21x15/1,5 mm n14	4x φ15x12 mm #16 r1	4x r42	1x z1	

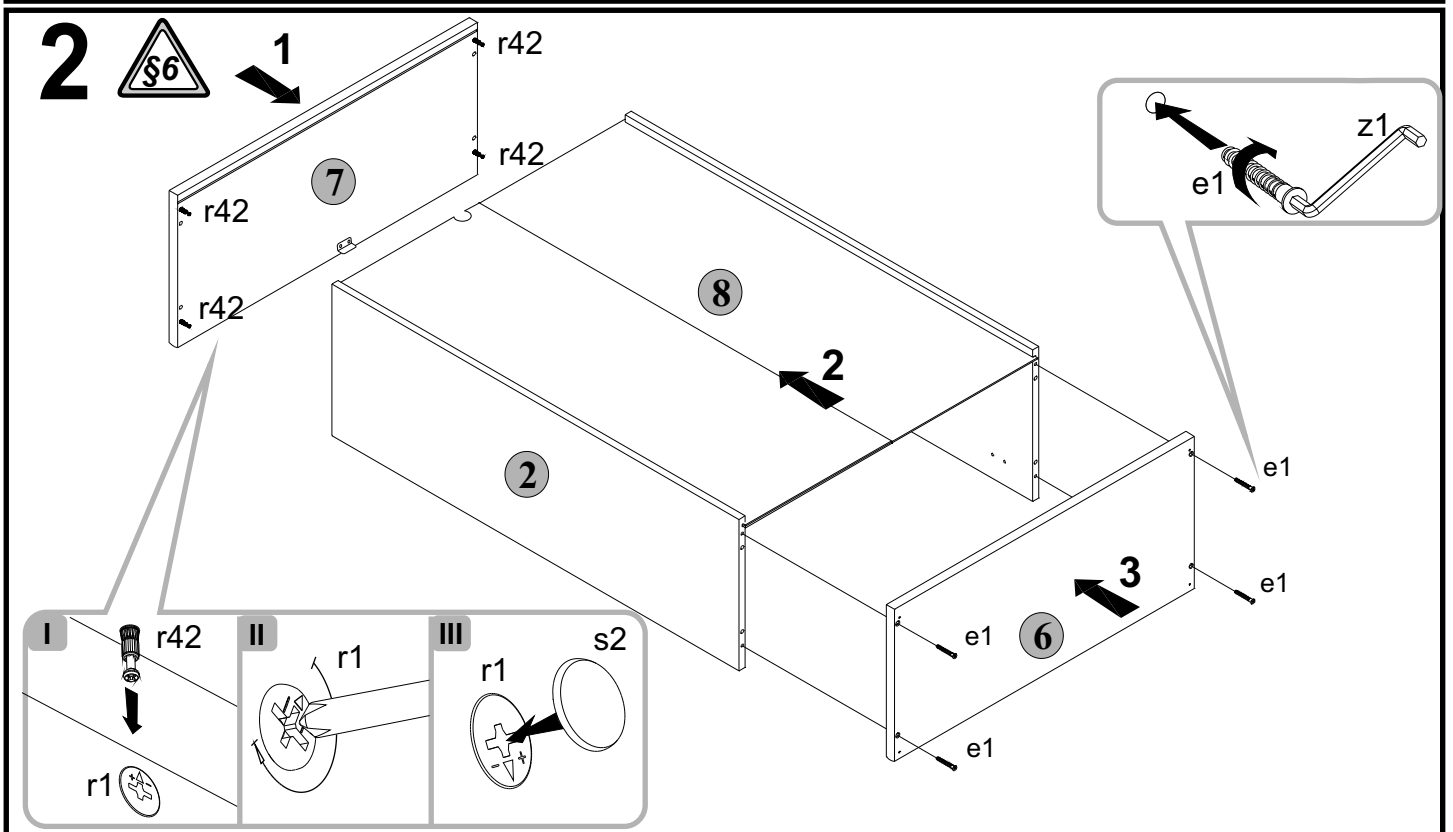
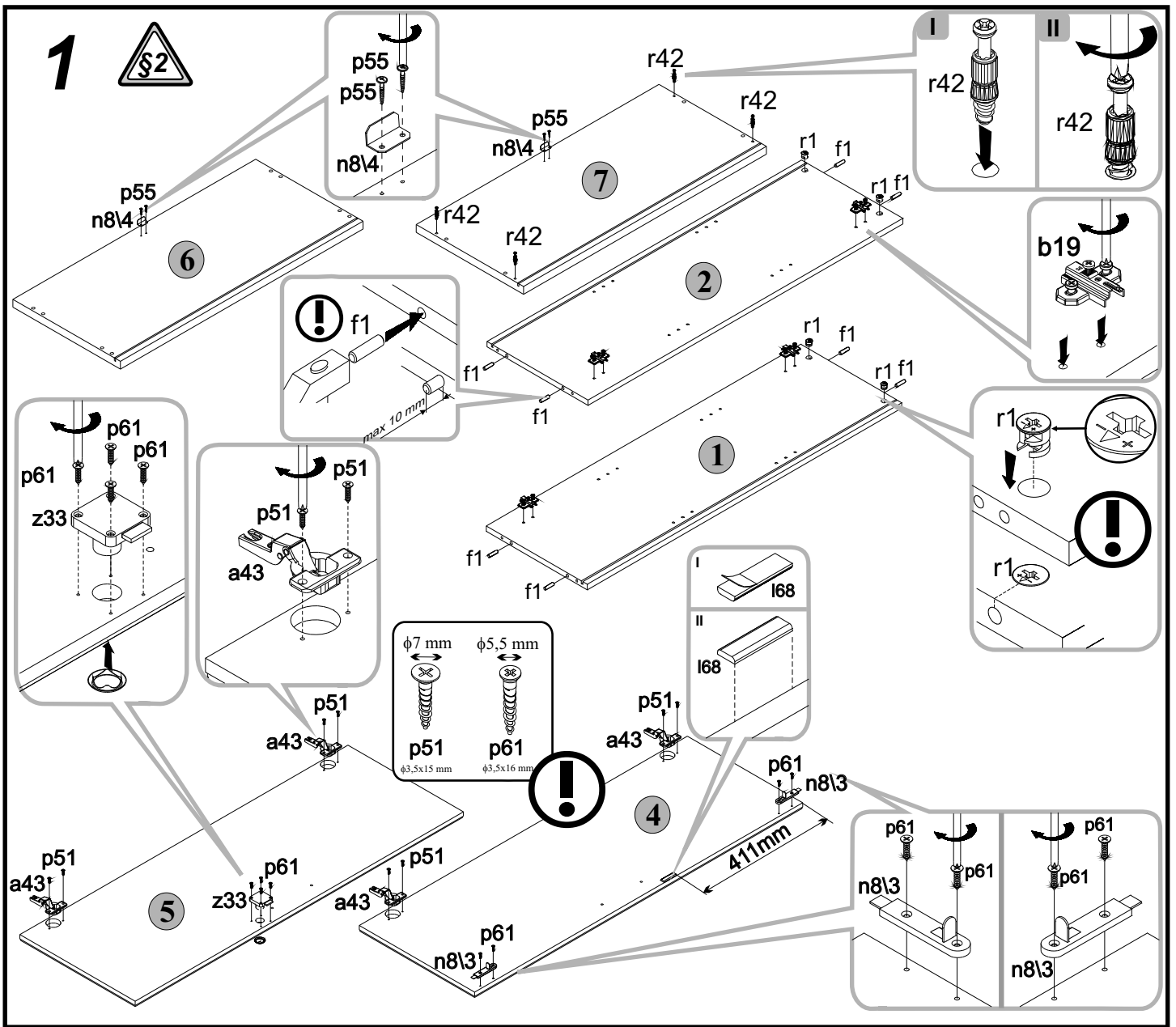

3

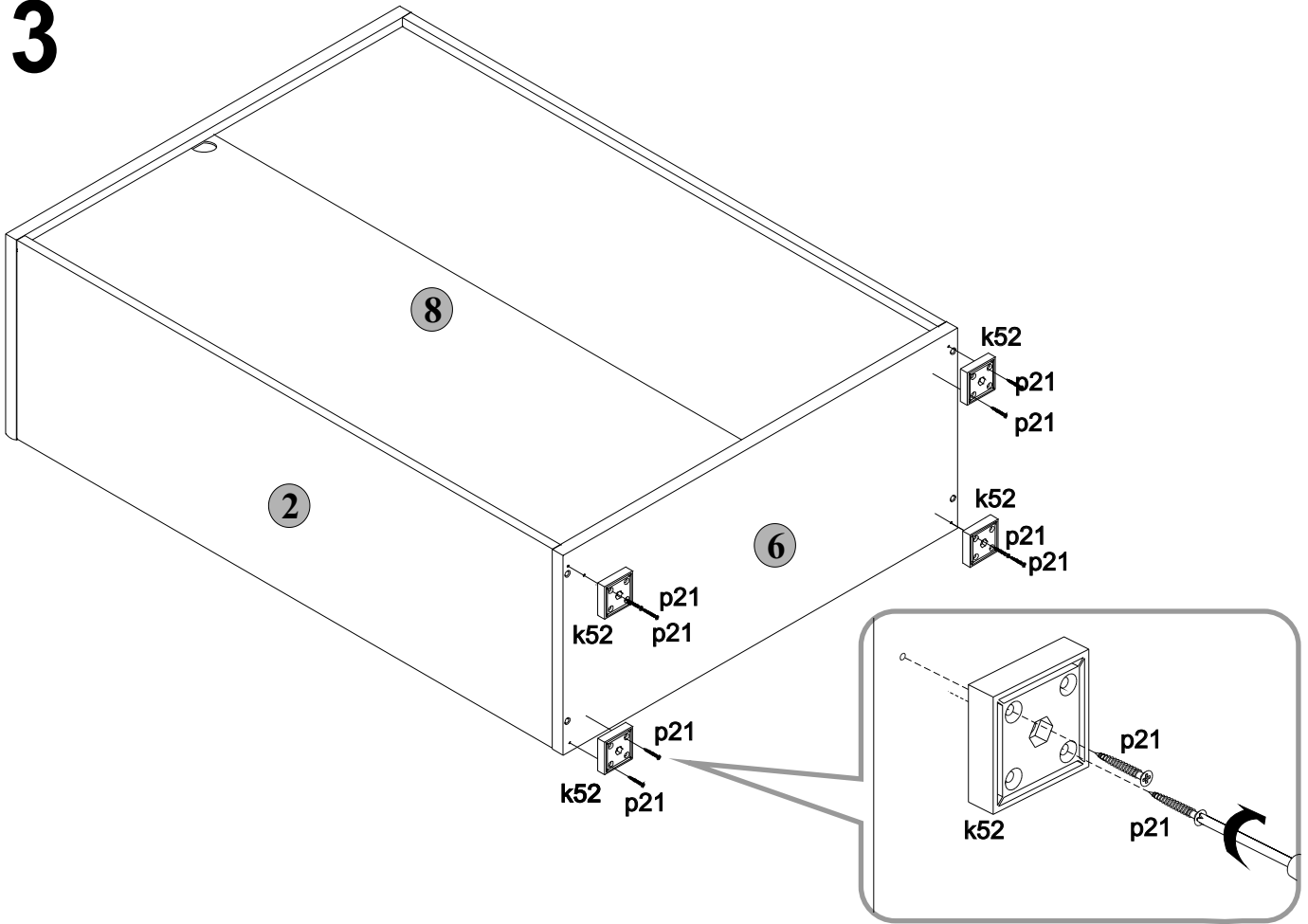

4

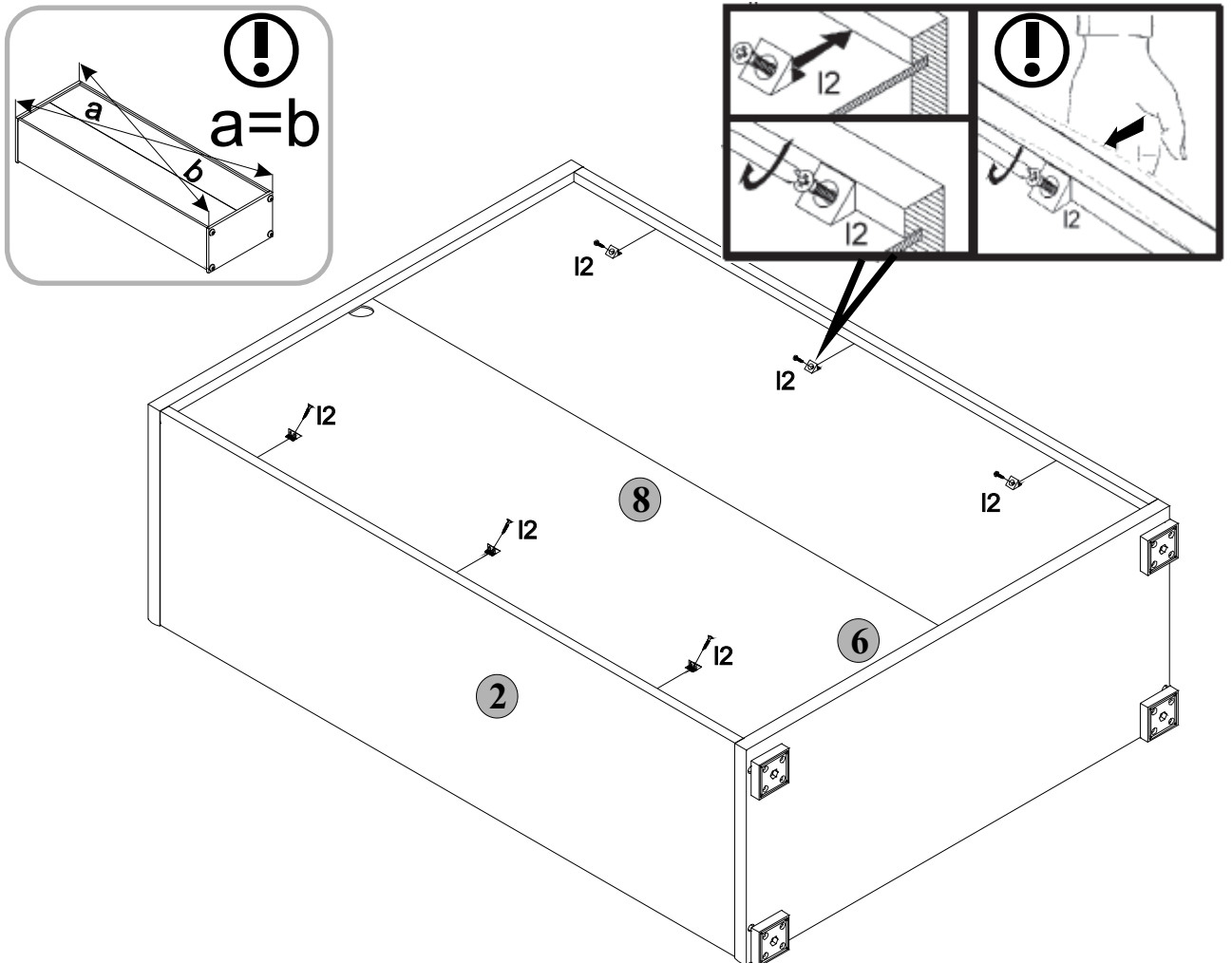

5

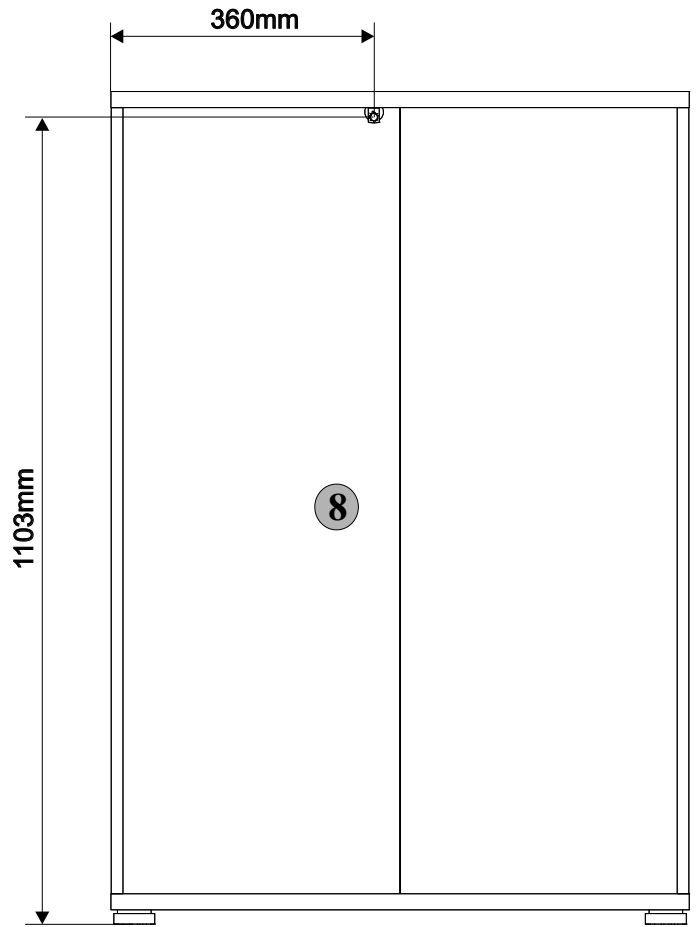
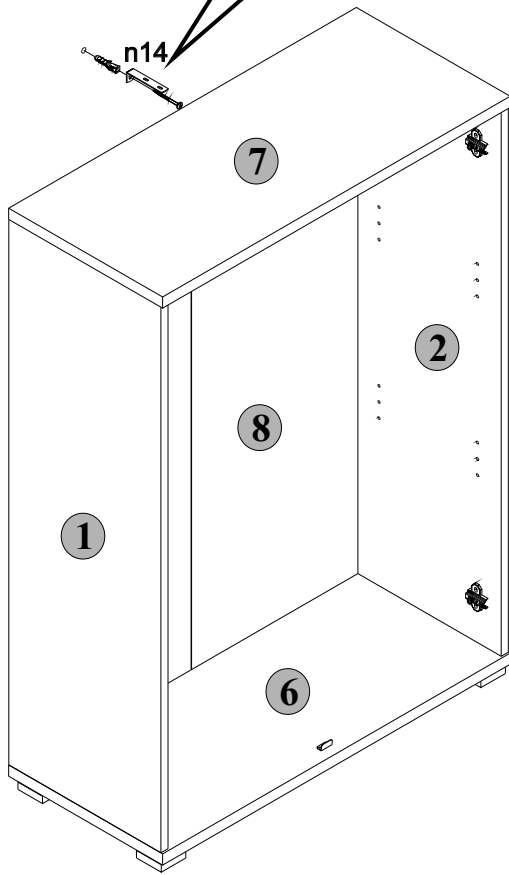
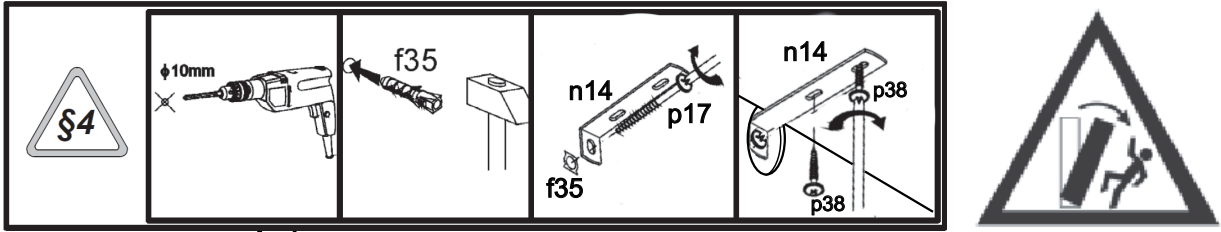

6

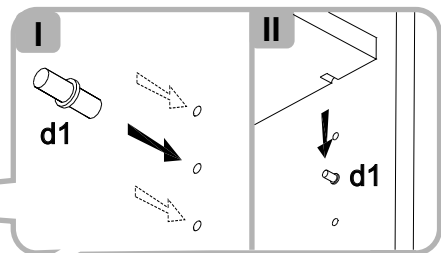
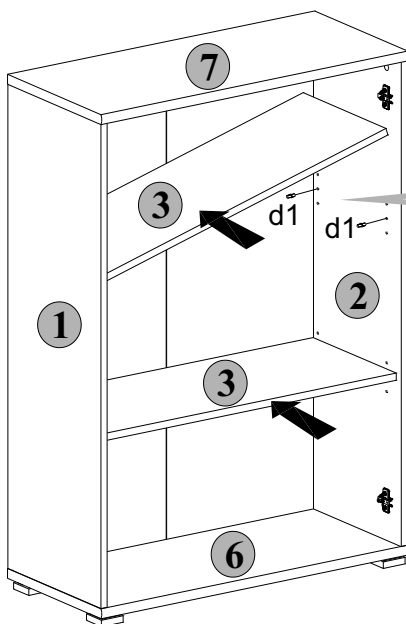

7

